

Zawias Silento PRO Hinge Silento PRO Петля Silento PRO

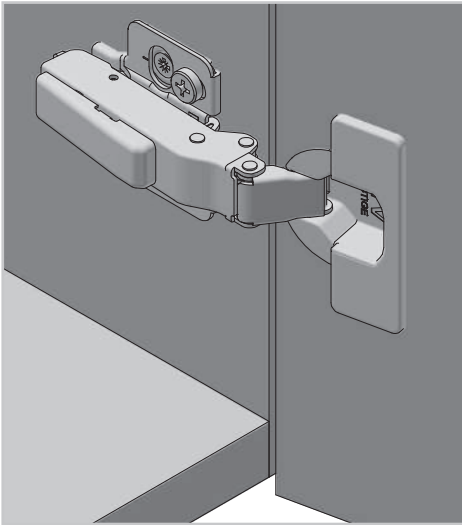

NAŁOŻENIE FRONTU / FRONT OVERLAY / НАЛОЖЕНИЕ ФАСАДА

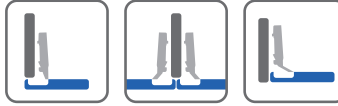

PARAMETRY / CHARACTERISTICS / ХАРАКТЕРИСТИКИ

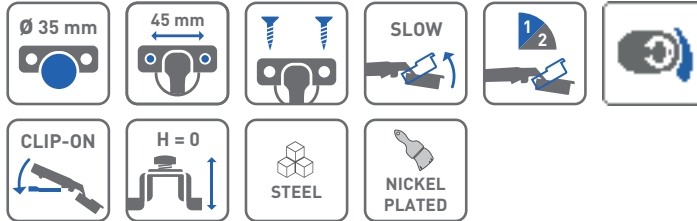

SKŁAD ZESTAWU / SET INCLUDES / КОМПЛЕКТАЦИЯ

ZAWIAS NAKŁADANY
OVERLAY FRONT
НАКЛАДНАЯ ПЕТЛЯ

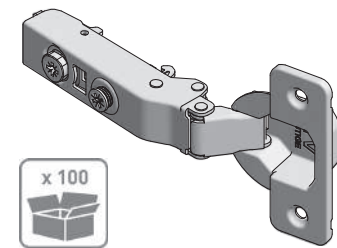

ZM-HCSL09-3D	-	-

ZAWIAS BLIŹNIACZY
HALF OVERLAY FRONT
ПОЛУНАКЛАДНАЯ ПЕТЛЯ

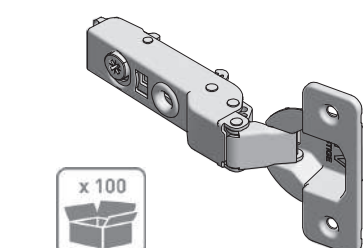

ZM-HCSL08-3D	-	-

ZAWIAS WPUSZCZANY
INSET FRONT
ВНУТРЕННЯЯ ПЕТЛЯ

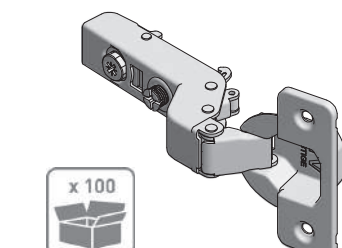

ZM-HCSL07-3D	-	-

PROWADNIK KRZYŻOWY
CROSS MOUNTING PLATE
КРЕСТОВАЯ ОТВЕТНАЯ
ПЛАНКА

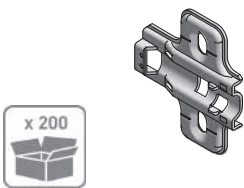

H0	PZ-HCSL-H0-BE0	-	-
	PZ-HCSL-H0-ZE0	-	2

PROWADNIK Z REGULACJĄ
MOUNTING PLATE WITH
ADJUSTMENT
ОТВЕТНАЯ ПЛАНКА
С РЕГУЛИРОВКОЙ

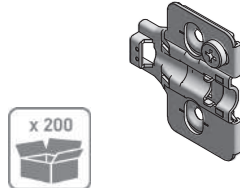

H0	PZ-HCSL3D-H0-BE0	-	-
	PZ-HCSL3D-H0-ZE0	-	2

PROWADNIK KRZYŻOWY + MUFY
CROSS MOUNTING PLATE
+ PLASTIC SOCKETS
КРЕСТОВАЯ ОТВЕТНАЯ ПЛАНКА
+ ВТУЛКИ ПЛАСТИКОВЫЕ

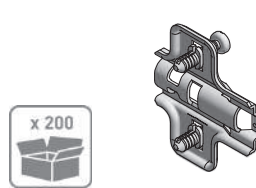

H0	PZ-HCSL-H0-M5	-	-

ZĄSLEPKI - KOMPLET
COVER CAPS - SET
ЗАГЛУШКИ - КОМПЛЕКТ

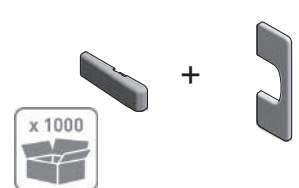

H0	ZM-COVERHCSL-SET	-	-

PLANOWANIE / PLANNING / ПРОЕКТИРОВАНИЕ

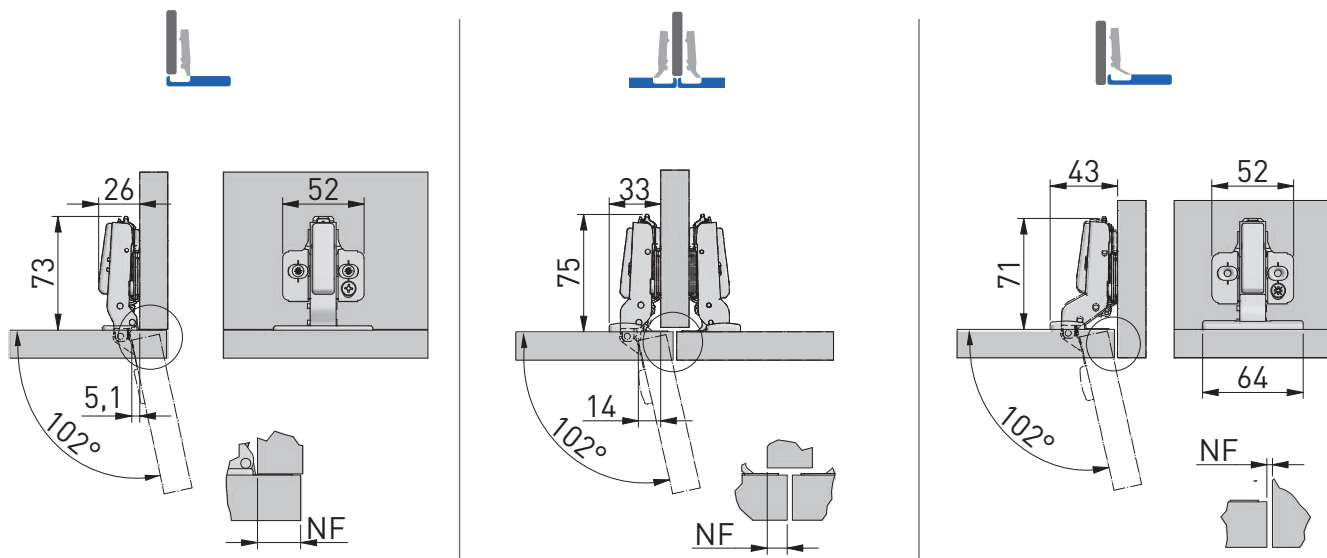

MONTAŻ / MOUNTING / МОНТАЖ

montaż prowadnika w korpusie
mounting plate installation
присадка под ответную планку

montaż puszki we froncie
hinge cup installation
присадка под чашку петли

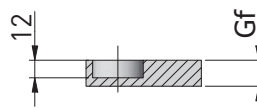
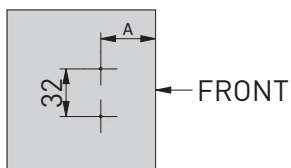

16 mm ≤ Gf ≤ 18 mm

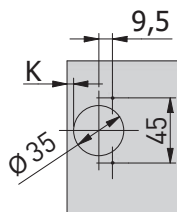
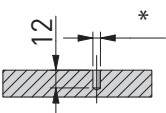
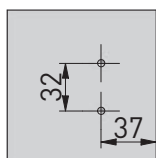

A = 37	A = 37	A = 37 + Gf + 1,5

NF	14	15	16	17	18	5	6	7	8	9	-4	-3	-2	-1	0
H = 0	K	3	4	5				3	4	5			3	4	5

A = odległość prowadnika od krawędzi (mm)
gap between mounting plate and the cabinet edge (mm)
расстояние от ответной планки до края (мм)

NF = nalożenie frontu (mm)
front overlay (mm)
наложение фасада (мм)

H = wysokość prowadnika
mounting plate height
высота ответной планки

K = odległość puszki od krawędzi (mm)
gap between hinge cup and cabinet edge (mm)
расстояние от чашки петли до края (мм)

Gf = grubość frontu
front thickness
толщина фасада

REGULACJA / ADJUSTMENT / РЕГУЛИРОВКА



± 2 mm



± 1,5 mm



± 1,5 mm